

Model CFF R-134a Container Refrigeration Machinery Product Specification



Table of Contents

| | |
|---|----|
| General description | 3 |
| Design Standard Information | 4 |
| Unit Capacity | 5 |
| Temperature Control | 6 |
| Detailed Information – Components | 7 |
| Microprocessor | 12 |
| Graphs, Drawings, Installation diagrams | 18 |
| Revisions | 23 |

Product specification

General description

| | |
|---|---|
| Manufacturer | THERMO KING CORPORATION |
| Type of System | Picture frame, electric cooling and heating single piece condenser / evaporator unit. |
| Construction | The refrigeration machinery is of the picture frame type. The frame is constructed of aluminum, treated to resist corrosion induced by salt spray atmosphere. The evaporator door is a bolted type. The rear bulkhead panels are constructed of aluminum with a high inherent corrosion resistance. Between the evaporator and condenser section the unit is insulated with fire resistant (according to ISO 3582) and CFC-free polyurethane foam. The nominal density of the foam is 32 kg/m ³ (2 lbs/ft ³). Average thickness is 52 mm (2 inches). |
| Dimensions | Width 2 025.5 mm (79.75 in) Height 2 235.2 mm (88.00 in) |
| Weight | 360 kg (794 lbs) |
| Electrical System Design | Electrical system designed to comply with ISO 1496 Standard. Designed to operate on: 400 to 500 VAC 3ph 60 Hz $\pm 2,5\%$ or 360 to 460 VAC 3ph 50 Hz $\pm 2,5\%$ |
| Control Circuit | 29 V ac for valve output – 29V ac for power module – 24 V ac for controller |
| Method of heating | Electric resistance |
| Air Exchange – Rotational Disk | 0 –100 m ³ /h |
| Air Exchange – Hinged Door | 100 m ³ /h, 150 m ³ /h, 175 m ³ /h, 215 m ³ /h, or 225 m ³ /h |
| Unit Air Leakage | Less than 0.5 m ³ /h at 76 mm wg (0.29 cfm at 3.0 in wg) |
| Unit Heat Leakage | Less than 3.4 kcal/h/°k (3.95 W/°k) |
| Paint Color (Powder or Liquid) | Off-white RAL 9016/85 (Unit) / Black (Tubing) |
| Aluminum Corrosion Protection (Unit White 'Powder' Paint) | The unit is pre-treated then painted with Infralit Polyester powder according to ISO test 7253 and 2409 classification 1. A Polyester Powder topcoat is applied to a film thickness of 100 μ meters. |
| Refrigerant | R-134a 5.2 kg (11.4lbs) – GWP 1300 (IPPC AR5). R-513A as future drop-in. |

| | |
|--|---|
| The equipment is designed to withstand and operate satisfactorily under sea-going and environmental conditions | |
| Ocean Environment | Salt-laden air, sea spray, high humidity and severe atmospheric conditions. |
| Rolling | Amplitude of 30° on each side, periods of 13 seconds |
| Pitching | Amplitude of 6° periods of 8 seconds |
| Permanent List | 10° on each side |
| Shock | Acceleration of 2g in all directions |
| Vibrations | Of the types encountered on ships, land vehicles and rails |

Product specification

Design Standard Information

| |
|---|
| The machinery is designed for long distance transportation of deep frozen, frozen, chilled, or heated cargoes in a temperature range of -30°C (-22°F) to 30°C (86°F). |
| The machinery will be fully functional and work satisfactorily, in ambient temperatures from -30°C (-22 F) to 50°C (122°F). Components are specified to withstand temperatures up to 70°C (158°F). |
| The noise level of units fitted into the container will not exceed 80dB in 250 Hz band. Measurement taken in front of the unit 1.5 m (59 inch) distance and 1.2 m (47.3 inch) above ground with the unit operating at 50 Hz. Per ISO 3744:2010 the sound power with set-point -30°C (-22°F) operating 400V/50Hz will not exceed 91 dB(A). Per ISO 3744:2010 the sound power with set-point -30°C (-22°F) operating 460V/60Hz will not exceed 95 dB(A). |
| AHRI - test method for rating refrigerated equipment. |
| Machinery complies with International Customs Regulations for Containers. |
| Machinery complies with relevant ISO standards for Refrigerated Container Machinery |
| Machinery complies with rules of ABS, BV and Lloyds. |
| Unit air leakage complies with Controlled Atmosphere requirements. |
| Refrigeration machinery complies with the requirements of the ATP regulations. |
| Unit complies with Australia and New Zealand Health Requirements. |
| Unit control system is prepared for power management (according to customer's requirements). |
| Unit complies with ATO (former Sprenger Institute) requirement regarding airflow. |
| Unit complies with USDA requirements regarding data logging and Cold Treatment |

Product specification

Unit Capacity R-134a

| | | | | | |
|--|--|--------------|------------|----------------|---------------|
| | Test method according to AHRI standard 1110 (I-P)-2013. Unit mounted in test room | | | | |
| | Net cooling capacity at 37.8°C (100°F) ambient temperature at 60 Hz power | | | | |
| Evaporator Return Air Temperature | Power requirement Watt | Watts | COP | KCal/hr | BTU/hr |
| 21.1°C (70°F) | 10,849 | 17,572 | 1.62 | 15,109 | 59,921 |
| 1.7°C (35°F) | 8,782 | 10,363 | 1.18 | 8,911 | 35,338 |
| -17.8°C (0°F) | 5,641 | 5,999 | 1.06 | 5,158 | 20,457 |
| -28.9°C (-20°F) | 4,544 | 3,251 | 0.72 | 2,796 | 11,086 |
| | Net heating capacity (including fan heat) at 60 Hz power | | | | |
| System heating capacity | 5,250 | | 4,515 | | 17,914 |

Product specification

Temperature Control

| |
|--|
| <p>Chilled Mode</p> <p>Evaporator Coil Temperature must be below 5 °C (41 °F) to activate the defrost compressor hour timer.</p> <p>There is an interval set for defrosting, however, the defrost timer is built intelligent - it detects whether or not there is ice building up on the coil.</p> <p>If there is no ice building up on the coil, it extends the defrost interval, and if there is Ice building up earlier on the coil it reduces the defrost interval. The maximum interval is 48 hours.</p> |
| <p>Frozen Mode</p> <p>With the temperature setpoint at -10 °C (14 °F) or below the unit will function from the return air sensor. If the return air temperature decreases by 2 °C (1.8 °F) below setpoint, the compressor stops until the temperature has risen to 0.2°C (1.8°F) above set-point. The evaporator fans run in high speed or stop running. Except during defrost where the fans are turned off.</p> <p>ON - OFF cycling of the compressor is minimum 6 minutes on and minimum 6 minutes off. Both, heating and modulation control are locked in frozen mode.</p> |
| <p>Defrost</p> |
| <p>Demand</p> <p>The defrost initiation is controlled by the defrost sensor, located in the evaporator coil. This sensor will activate the demand cycle when the temperature difference between return air sensor and defrost sensor increases to a pre-set value. A probe status entry is made in the event log to note a demand cycle vs. a timed cycle. For additional security, defrost will also be initiated on a timed basis.</p> |
| <p>Timed</p> <p>Chilled/Cooling mode</p> <p>When starting the unit with supply air temperature at 8°C (41°F) or below, the initial defrost timer interval is two hours and increases up to 48 hours by detecting the need for defrost. The timing is increased or decreased depending on time to next activated defrosts.</p> <p>Frozen mode</p> <p>When starting the unit in frozen mode (below -10°C / 14°F), the initial defrost timer interval will be eight <i>compressor</i> hours and increases by two hours up to a twenty-four hour interval on time activated defrosts.</p> <p>If the unit has been switched off for more than twelve hours or if the setpoint has been changed more than 5° C (9°F), the timer will be reset. If not, the unit will start with the same defrost sequence set by the above rules.</p> |
| <p>Termination</p> <p>The defrost sensor terminates the defrost cycle automatically when the temperature in the evaporator coil rises to:</p> <ul style="list-style-type: none"> • 18 C or higher than 8°C (46.4°F) in 35 minutes in frozen and chilled mode • If running in dehumidification special rules for defrost termination. |

Product specification

Detailed Information - Components

| Compressor | | | |
|----------------------|----------------------------------|------------|--|
| Manufacturer | Copeland | Type | ZMD27KVE-TFD |
| Protection | Internal thermal automatic reset | Nominal HP | 6 |
| Locked Rotor Current | 75 A @460 V / 60 Hz | Finish | Pre-treatment: Grit blast, NACE No. 1/SSPC-SP5 Finish: Listed in application order: 1. Thermally sprayed aluminum, minimum thickness of 254 µm (0.010 in) 2. Sealer per MIL STD TT-P-28, dry film thickness of 15.2 – 25.4 µm (0.0006 – 0.001 in) |
| | | Weight | 45 kg / 99 lbs |

| Evaporator Coil | | | |
|-----------------|--|---------------|--|
| Manufacturer | Dunan | Configuration | Horizontal |
| Tube material | Copper. According to DIN 1787 wall thickness 0.45 mm | Fin material | Special Aluminum DIN 1712/A199 |
| Circuits | 16 | Fin space | 3.17 mm |
| Surface area | 51.6 m ² (555 ft ²) | Protection | Fin material pre-coated with hydrophilic coating. Coating also provides additional corrosion protection. |

| Condenser Coil | | | |
|----------------|--|---------------|--|
| Manufacturer | Dunan | Configuration | Circular |
| Tube material | Copper. According to DIN 1787 wall thickness 0.45 mm | Fin material | Aluminum |
| Surface area | 33.4 m ² (360 ft ²) | Fin space | 2.0 mm |
| | | Protection | Epoxy E-Coat with Polyurethane topcoat for UV protection. Coating also provides additional corrosion protection. |

| Economizer | | | |
|---------------|--------------|------------------|-----------------|
| Technology | Brazed plate | Brazing Material | Copper |
| Configuration | Counter Flow | Plate Material | Stainless Steel |

Product specification

Detailed Information – Components (continued)

| Evaporator Fan | | | |
|----------------|--|-------------------------|--|
| Type | Propeller | Diameter | 355 mm (14 inch) |
| Number of Fans | 2 | High Speed Low Speed | 3450 rpm at 60 Hz 1725 rpm at 60 Hz |
| Blade material | Glass reinforced polypropylene | Drive | Direct on motor shaft |
| Hubs Material | Glass reinforced polypropylene with stainless steel ring | Number of blades | 6 |
| Air Flow | See graph pages 18-19 | Pitch | 25° |

| Condenser Fan | | | |
|----------------|--|------------------|-----------------------|
| Type | Propeller | Diameter | 550 mm (22 inch) |
| Number of Fans | 1 | Speed | 1750 rpm at 60 Hz |
| Blade material | Glass reinforced polyamide | Drive | Direct on motor shaft |
| Hubs Material | Glass reinforced PBT, and stainless steel ring | Number of blades | 8 |
| Air Flow | 6 000 m ³ /h 3 531 CFM | Pitch | 30° |

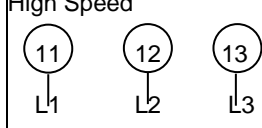
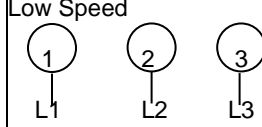
| Evaporator Fan Motors | | | |
|-----------------------|---|------------------|---|
| Nominal KW | 0.75 kW 1.0 – 0.25 hp (60 Hz) 0.83 – 0.20 hp (50 Hz) | Type | Completely enclosed with separate windings for high speed, low speed, and non-ventilated |
| Speed | 3 450 - 1 725 rpm (60Hz) 2 875 - 1 440 rpm (50Hz) | Protection | Internal thermal automatic reset (each winding) |
| Shaft Material | 303 Stainless steel | Bearing | Ball – double sealed full contact seals (Grease - Mobil 28) |
| Finish | Iron phosphate pre-treatment, cathode epoxy e-coat prime coat, black epoxy top coat | Lead Connections | High Speed  Low Speed  |
| No. of Motors | 2 | IP | 56 |

Product specification

Detailed Information – Components (continued)

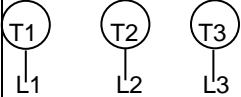
| Condenser Fan Motor | | | |
|-----------------------|--|-------------------------|---|
| Nominal kW | 0.55 kW | Type | Completely enclosed non-ventilated |
| | 0.75 hp (60 Hz) | | |
| | 0.63 hp (50 Hz) | | |
| Speed | 1 725 rpm (60 Hz) | Bearing | Ball – double sealed full contact seals |
| | 1 425 rpm (50 Hz) | | (Grease – Mobil 28) |
| Shaft Material | 303 Stainless steel | Protection | Internal thermal auto. reset |
| No. of Motors | 1 | IP | 56 |
| Finish | Iron phosphate pre-treatment, cathodic epoxy e-coat prime coat, black epoxy top coat | Lead Connections |  |

| Defrost Heaters | | | |
|--|---------------------------|-------------------------------|---|
| Defrost drain pan with high edges, 2 drains and plastic hose. Drain complies with TIR requirements. | | | |
| Drains are located in close proximity to condenser coil and compressor to prevent icing in cold ambient. | | | |
| Defrost Heater | 1360 W each @ 265 V/60 Hz | No. of Defrost Heaters | 3 |

| Electrical Safety Controls | | | |
|----------------------------|----------------------------------|-----------------------------|------|
| Compressor Motor | Internal thermal automatic reset | Main Circuit Breaker | 25 A |
| Condenser Motor | | | |
| Evaporator Motor | | | |

| Control Valves | | | |
|-----------------------|---------|-----------------|---------------------------------------|
| Valve | Voltage | Normal Position | Function |
| Digital Control Valve | 24 Vac | Closed | Controls the compressor loading |
| Economizer Valve | 24 Vac | Closed | Turns the economizer cycle on and off |

| Refrigeration Safety Controls | | | |
|--------------------------------|------------------------------------|-----------------------------|-----------------------|
| Low Pressure Switch | Cut-out: -7.8 - -4.9 psig | High Pressure Switch | Cut-out: 334 ±15 psig |
| | Cut-in: 20 ±5 psig | | Cut-in: 247 ±21 psig |
| Fusible Plug (Receiver) | Relief Temperature 99°C (210°F) | | |

Product specification

Detailed Information – Components (continued)

| Electrical Panel Components | | | |
|-----------------------------|--|-----------------------------|--|
| Contactors | Compressor CI25 | Main Circuit Breaker | 25A |
| Solid state | Condenser Fan, Heater, Evaporator Fan (2 pcs.) | Fuse | 3 x 20 A on Power Module Control circuit and output protected by multifuses |
| Relays | Phase Selection (2 pcs.) | | |
| Transformer | Primary 500 V ac Secondary 29/29/24 V ac | Phase Sensor | Automatic selection |
| Switch | Unit "ON / OFF" | Battery Backup | 3.7 Volt service free 2150mAh Capacity |

| Power Plug | | | |
|--|-----------------------------------|--------------|--------|
| Type CEE 17 (ISO 1496-2, Annex 0 0,1) | 4 pole 400 / 460 Volt 50/60 Hz | Amps | 32 |
| Manufacture | Mennekes | Earth | 3h pos |

| Power Cable | | | |
|---|-----------------------------------|--------------|--|
| Storage for power cable provided in condenser section | | | |
| Length | 18.3 m (60 ft) | Cable | 4 x 4 mm ² , 450/750 V QWPK (11ga/4 conductor) |
| Temperature Range | -37° C (-35° F) to 90° C (194° F) | Color | Yellow |

| Datalogger Download Plug | | | |
|--------------------------|---|-------------|---------------------|
| Location | One on the electrical box and one on back side of container unit (at USDA panel). | Type | Deutsch HD10-5-16-P |

| USDA Receptacle | | | |
|-------------------------------|-------------------------------------|-------------------------------|-------|
| Receptacle type 3 pole | Deutsch or similar HD10-3 96 (Male) | Sensor connection type | NTC |
| Location | Rear left side | Quantity | 4 pcs |

Product specification

Detailed Information – Components (continued)

| De-Humidification Control | | | |
|--|--------------|-------------------------|--|
| Humidity reduction is accomplished by re-heating the evaporator air with the defrost heaters. A control algorithm allows to set humidity set-point between 50% and 98%. The de-humidification performance depends on several external parameters and in particular conditions, the exact set-point value may not be reached. The Condensate is drained to the outside via the defrost drain tubing. Option includes; humidity sensor installed in return air and all required wiring and control software. | | | |
| Humidity Sensor | | | |
| Operational Range | 50% - 98% RH | Accuracy | at 50% to 75%: $\pm 1.5\%$ at 75% to 95%: $\pm 3.0\%$ |
| Output Signal | 4 mA - 20 mA | Output per 1% RH | 0.20 mA |

Miscellaneous

| |
|---|
| One piece removable evaporator access door |
| Safety harness hooks and grab-handle |
| Suction and Discharge Service Valves |
| Refrigerant service connections per SAE J639 (R134a automotive type) located on suction and discharge side of the compressor. |
| Solid State Microprocessor Controller with Backlit 1/4 VGA Graphical Type Display, 28 mm (1.1 inch) |
| Non Optimized can be selected in chilled mode |
| Sequential component start to minimize peak amp draw |
| Auto PTI Includes function tests and fault diagnostics |
| Tin-plated and numbered wires according to UL1647 |
| Unique fresh air change system integral ducting for wall to wall air distribution. |
| op |

Product specification

Microprocessor Controller MP-4000

BRIEF Functional description

This is a short description of the MP-4000, environmental specifications and specification of power supply voltages for the MP-4000.

The MP-4000 is a control box for a reefer container. The MP-4000 includes two main building blocks: the Power Module PM-4000, a high voltage interface module based on solid-state technology, and the Controller Module CM-4000, the system control unit holding the application.

The MP-4000 is solely responsible for the regulation of the reefer container, but other monitoring equipment without regulation functionality such as a chart recorder can be used together with the MP-4000.

The MP-4000 is designed for a Thermo King Magnum+ and CFF units; this control box will support no other Thermo King Refrigeration units.

The basic concept behind the MP-4000 container controller is that all high voltage functionality is located at one module and all low voltage functionality and application is handled by a second module.

Furthermore, the system includes two interfaces slots containing power and communication for expansion modules, which should enable the MP-4000 to meet future requirements. User interface is on the Front Door of the MP-4000. At the Front Door is a display, a keyboard and a retriever port for cargo data retrieving and maintenance download is available for the user.

The MP 4000 consists of the following:

Controller Module w/ Integrated Data logger, CM4000

Power Module, PM4000

Front Door

Power Module, PM-4000

The PM-4000 interfaces directly to the power line. The module controls the various high voltage elements of the reefer container and also holds the ISO10368 compliant Power Line Modem.

The serial communication between the CM-4000 and the PM-4000 is a RS232 (logic level) containing two communication lines and additional signals for changing code in the PM-4000. This interface is galvanic isolated and the isolation barrier is located in the PM-4000.

Controller Module, CM-4000

The CM-4000 controls and monitors the environment inside the reefer container in order to meet the required conditions for the cargo during transportation.

The CM-4000 is an intelligent controller module containing the low voltage outputs and inputs for the reefer container and holds the application.

The RS232 interface to the user is a retriever port and is used for retrieving cargo data and SW maintenance on all modules including possible expansion modules.

The RS485 interface is available for external communication with Chart Recorder, or alternative devices.

A battery package is integrated on the CM-4000 and support the CM-4000 with power when there is no AC power connected and logging is required.

Product specification

Microprocessor Controller MP-4000 (continued)

Front Door

The Front Door of the MP-4000 has an integrated user interface.

The display is a ¼ VGA monochrome graphical display with 16 gray scales. The display can be read without backlight but is equipped with backlight for better readability.

The keyboard is build with tactile switches and protected by a Front foil on the Front Door.

The retriever port is located on the Front Door for easy access, but is fed through to the CM-4000.

The Door can be closed by hand but a tool is needed to open it. A heavy duty screw driver is recommended (Slotted max 2x10mm). The screw driver is put into the gab to the right on the MP-4000 Door and the screw driver is forced by hand to the left to open the Door.

Cleaning and degreasing of the Front Door or the Front foil by means of wiping off can be performed using isopropyl alcohol, heptanes or mild soap solutions. The parts should not be cleaned with partially hydrogenated hydrocarbons or strong oxidizing acids.

All the plastic parts are made of chlorine and bromine free flame retardant PC-ASA.

All metal sheet parts are made of Aluminum 5052-H32 or 5754-H32.

Technical specification

- 24V ac power input for controller.
- Separate AC power input for solid state outputs.
- Interface to the MP-4000 front door containing 5.7" ¼ VGA LCD and Keyboard.
- RS232 interface for data and event log retrieval & application upload.
- RS485 connection for expansion modules and system integration.
- Serial connection for the PM-4000 power module.
- SD-CARD slot for external data memory.
- Self-contained rechargeable battery for battery operation.
- Real Time Clock with separate battery back-up.
- Input output section containing:
 - Two Digital solid state AC outputs, short circuit protected.
 - Digital input for potential free contacts.
 - Four CARGO inputs, for 2-wire NTC probes.
 - Six reefer unit inputs, for PT1000 probes.
 - NTC input for compressor temperature.
 - Analogue input for 4-20mA.
 - Three analogue inputs for 0-5V.
- Two expansion slots for various function i.e.:
 - AFAM control
 - RM4 / Bridgelight
 - RMM-W
- Two LED's. Definition:
 - 1. Red Flashing – Alarm present and must be acknowledged
 - 2. Red Solid – Alarm present and does not need to be acknowledged
 - 3. Green Flashing – Temperature approaching In Range
 - 4. Green Solid – Temperature In Range

Product specification

Microprocessor Controller MP-4000 (continued)

With exception of the sensors, all components are mounted in the control box. The design of the microprocessor provides permanent accuracy, reliability, and expandability.

In the case of a control sensor failure, another sensor will take over and automatically compensate for the difference between supply and return air temperatures.

A permanently stored base program is built into the controller and a non-volatile memory for when additions or changes in software are present.

Overall accuracy is $\pm 0.25^{\circ}\text{C}$ ($\pm 0.4^{\circ}\text{F}$) and verification of temperatures should be carried out using an instrument with equal or better performance.

Sensors for Supply and Return air are PT1000 Class A per EN60751:2008 i.e. with accuracy of ± 0.15 deg C

Conformance / Compliance

2006/42/EC Machine Directive

EN ISO 12100:2010 Safety of machinery - General principles for design - Risk assessment and risk reduction

2014/35/EU Low voltage directive

2014/30/EU Electromagnetic Compatibility Directive (EMC).

EN 61000-6-1:2019 EN 61000-6-3:2019 EMC for Residential, commercial and light-industrial environments

Examination and tests performed of the products herein described and related documentation gives presumption of compliance for the EMC Directive 2004/108/EF, when installed and used according to the manufacturer instructions.

ISO10368 RMM; Mains signaling modem intended for connection to non-public power networks

IMO Green Passport (WEEE)

It is hereby stated that the products herein described all are made of a multitude of electronic and mechanical components which contains hazardous substance.

The recycling processes and disposal of these components should be disposed by following local waste regulations for electronic devices.

Product specification

Microprocessor Controller MP-4000 (continued)

Datalogger

The integrated data logger is a microprocessor-based recorder specifically developed for refrigerated containers.

The datalogger contains a memory area for storing temperatures.

All registrations are stored in the memory, which contains temperatures logged at user selectable intervals. The sensors logged are: supply air, return air, USDA, ambient and the Setpoint. Using a one-hour logging interval, temperature information covering the last 625 days is available. The logging of the USDA sensors are fixed at a one-hour interval automatically to comply with the USDA regulations.

One-minute log is only for calibration of USDA sensors.

All logs are stored at time and date of occurrence. The Real Time Clock in the controller is set at UTC time at the factory and is backed up by a built-in extended life Lithium battery. The datalogger is equipped with high-speed serial communications port. The logs can be inspected on the VGA display of the controller.

Retrieving the datalogger can either be done by use of a SD cart, Emerson Controls Logman, or via the REFCON / GRASP power line remote monitoring system. Retrieving by the REFCON / GRASP system requires that the controllers are equipped with ISO standard 10 368 high data rate, wide band, and power cable communication modems.

The datalogger will continue to log, 120 entries (at 1 hour interval) after the container has been turned OFF or disconnected from mains power source.

The datalogger menu contains a list of functions that display unit operating information recorded in the MP-4000 data logger however only since last power up on the display. The following functions are available:

Inspect Log: Displays results of last PTI, Event and Temperature test including component volt and amps data and sensor temperatures.

Calibrate Probe (Optional): Sets a temperature offset in the controller memory to calibrate each USDA sensor to the controller.

Set Log Time Interval: Sets the data log.

| | | | |
|-----------------------------|------------------|-----------------|---|
| Ambient Temperature | -25° C to +70° C | Humidity | 95% RH non-condensing |
| Temperature Accuracy | ±0.15 °C | Capacity | 1.2MB equal to approximately 2 years continuous logging of all sensors and events |

Product specification

Microprocessor Controller MP-4000 (continued)

Retrievable Data

The controller contains three memory areas for data: 1. Warnings / Alarms, 2. Auto PTI, 3. Comments, 4. Temperature log
The memory is 1.2MB big, giving the possibility to log continuously for approximately 2 years.

1. Warnings and Alarms:

This record contains the last 1 024 events, such as information on warnings/alarms, power on/off, defrost start/end, etc.

2. Auto PTI

Records of the last two Auto PTI's performed.

3. Comments:

Entering using the keyboard on the controller, sending by the Logman II handheld data retriever, or by the Thermo King Smart Sponge, comments can be entered to the controller memory.

4. Temperature log

See datalogger.

All logs are stored at time and date of occurrence. The Real Time Clock in the controller is set at UTC time at the factory and is backed up by a built-in extended life Lithium battery. The datalogger is equipped with high-speed serial communications port. The logs can be inspected on the LCD display of the controller.

Function and PTI Test

There are four standard test modes and one optional mode programmed in the microprocessor.

PTI. The MP-4000 controller contains a special Full PTI pretrip test that automatically checks unit refrigeration capacity, heating capacity, temperature control, and individual components, contactors, fans, protection devices and sensors. The test includes measurement of component power consumption and compares test results to expected values. The test takes up to 2 to 2.5 hours to complete, depending on the container and ambient temperature.

Brief PTI. This test is similar to the Full PTI, except the test takes about 25-30 minutes to complete, depending on the container and ambient temperature. As in the full PTI, detailed PTI test results are stored in the MP-4000 Datalogger for later viewing.

Function test. The controller contains a special function test that automatically tests individual components including, sensors, condenser fan, evaporator fan, compressors, etc. The test includes measurement of component power consumption and compares test results to expected values.

Manual Function test. Allows a technician to perform specific diagnostic tests on individual components or turn several components ON at the same time to perform a system test.

Product specification

Microprocessor Controller MP-4000 (continued)

Control alarms

Three types of alarms may occur.

1. Shutdown Alarm (Level 1): The alarm LED flashes and the unit stops. A shutdown alarm indicates that the unit has stopped to prevent damage to the unit or cargo. The condition must be corrected before the unit will restart.
2. Check Alarm (Level2): The alarm LED flashes until the alarm is acknowledged but the unit continues to operate. A check alarm indicates corrective action should be taken.

Sensor Alarms:

- If any sensor is defective (evaporator coil, return air, supply air, condenser coil, ambient air, or compressor discharge temperature).
- If the temperature difference between the evaporator coil, return air, or supply air sensors get either too high or too low in accordance with actual conditions.
- If the temperature difference between the two-supply air sensors is too high.

Temperature Alarm Chilling:

If temperature is not in range of $\pm 1.5^{\circ}\text{C}$ ($\pm 2.7^{\circ}\text{F}$) of the Setpoint within one hour of running, at settings of $-9,9^{\circ}\text{C}$ ($14,2^{\circ}\text{F}$) or higher. This in-range temperature tolerance is user selectable. The alarm is ignored if the temperature is falling / rising towards the Setpoint greater than 0.1°C (0.2 F) per hour when the temperature is within 5°C (9°F) of the Setpoint. This applies to both cooling and heating.

Temperature Alarm Freezing:

If temperature is not in range of $\pm 1.5^{\circ}\text{C}$ ($\pm 2.7^{\circ}\text{F}$) of the Setpoint within one hour of running, at settings of -10°C (14°F) or below. This in-range temperature tolerance is user selectable. The alarm is ignored if the temperature is falling / rising towards the Setpoint greater than 0.1°C (0.2 F) per hour when the temperature is within 5°C (9°F) of the Setpoint.

Defrost Alarm:

If defrost interval lasts more than 90 minutes or if return air temperature is $> 38^{\circ}\text{C}$ (100°F) at 60Hz operation or 120 minutes at 50 Hz operation.

Compressor Discharge Temperature: $> 130^{\circ}\text{C}$ (266°F).

Phase Sensing: If after 20 seconds, the controller is not able to decide the correct phase direction.

Pressure: If the discharge or suction pressure exceeds programmed limits.

Power: If the voltage, frequency, or total unit current exceeds programmed limits.

Temperature Sensors

The sensors (6) are PT1000 sensors (the first 5) and a thermistor design for the compressor. They are connected to the controller via a two-conductor cable.

1. Evaporator Coil - Located in the center of the evaporator coil
2. Return Air - Located in the return air section
3. Supply Air - Located in the supply air section
4. Condenser Coil - Located in the condenser coil
5. Ambient Air – Located on the unit front wall
6. Compressor – Located in the compressor head.

Product specification

Graphs, Drawings and Diagrams

Airflow

Fan at High Speed
(imperial units)

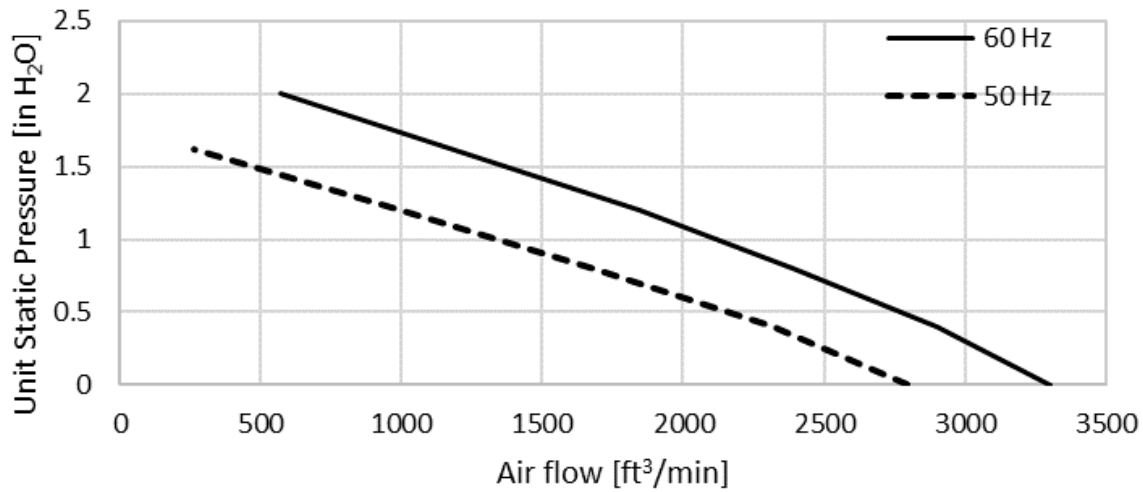

Fan at High Speed
(metric units)

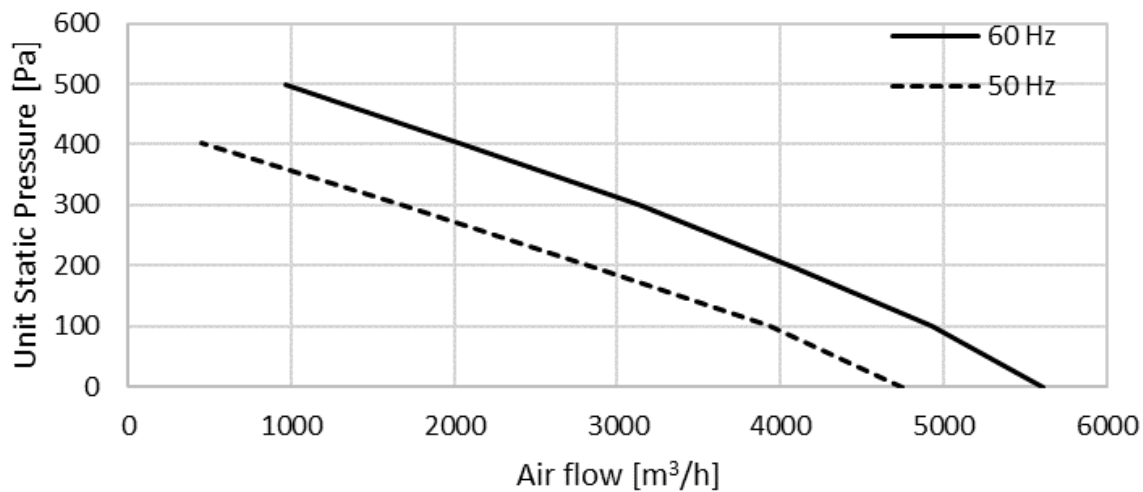

Product specification

Graphs, Drawings and Diagrams

Airflow

Fan at Low Speed
(imperial units)

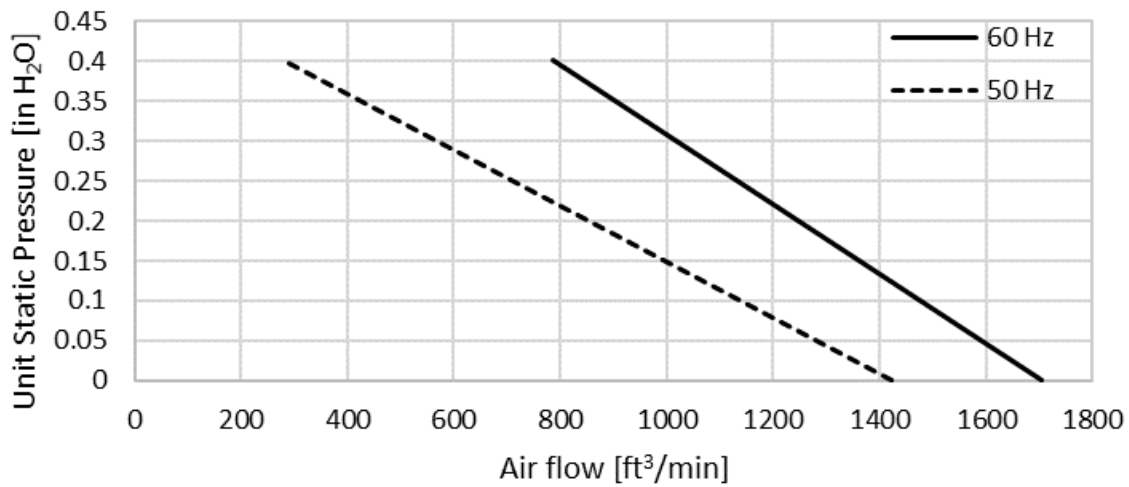

Fan at Low Speed
(metric units)

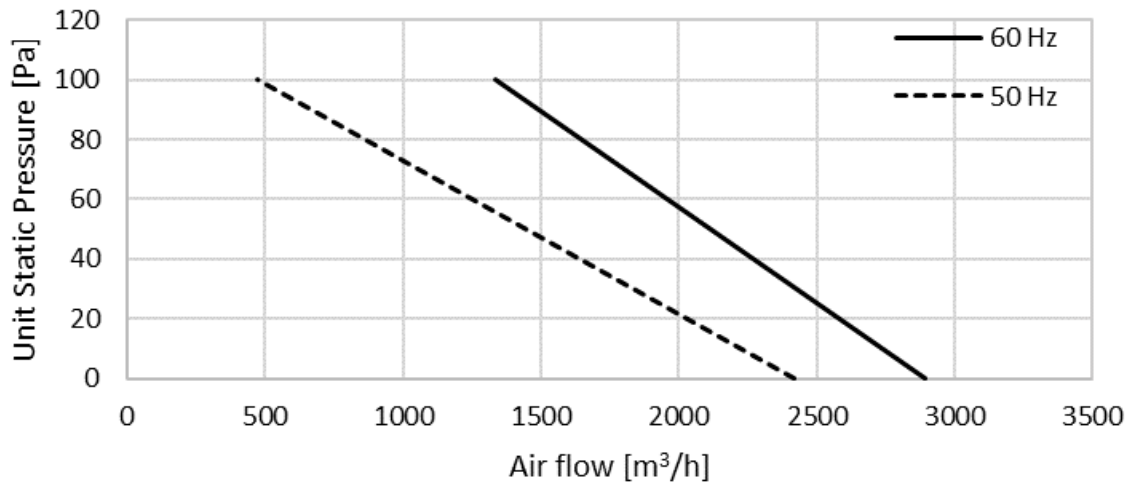

Product specification

Graphs, Drawings and Diagrams

Piping diagram

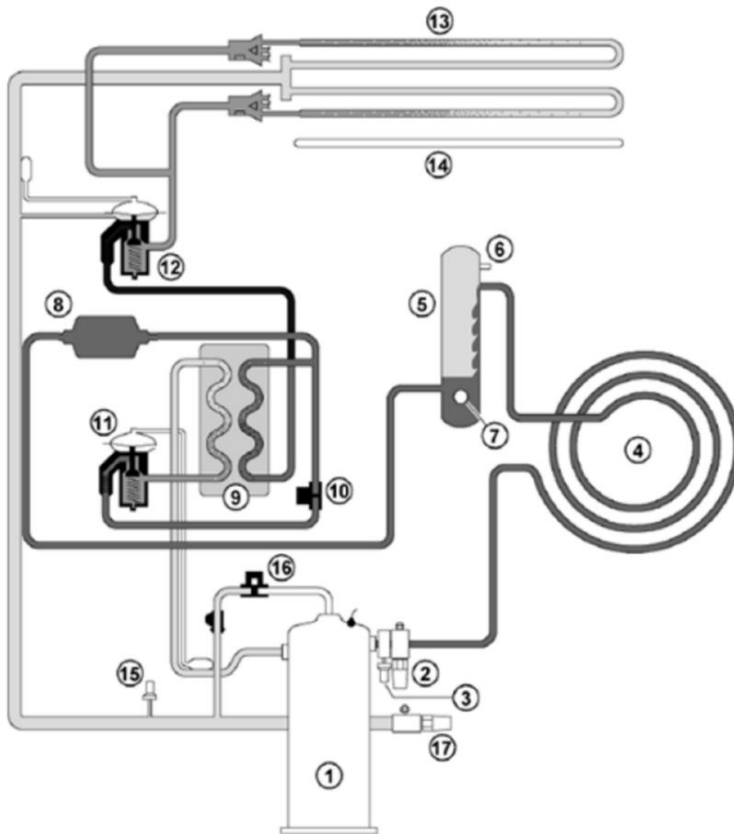

1. Scroll Compressor
2. Discharge Service Valve
3. High Pressure Switch
4. Condenser Coil
5. Receiver Tank
6. Pressure Relief
7. Sight Glass
8. Drier / Oil Filter
9. Economizer Heat Exchanger
10. Vapor Injection Valve
11. Economizer TXV
12. Evaporator TXV
13. Evaporator Coil
14. Heater
15. Low Pressure Switch
16. Digital Control Valve
17. Suction Service Valve

Product specification

Graphs, Drawings and Diagrams

Installation Diagram

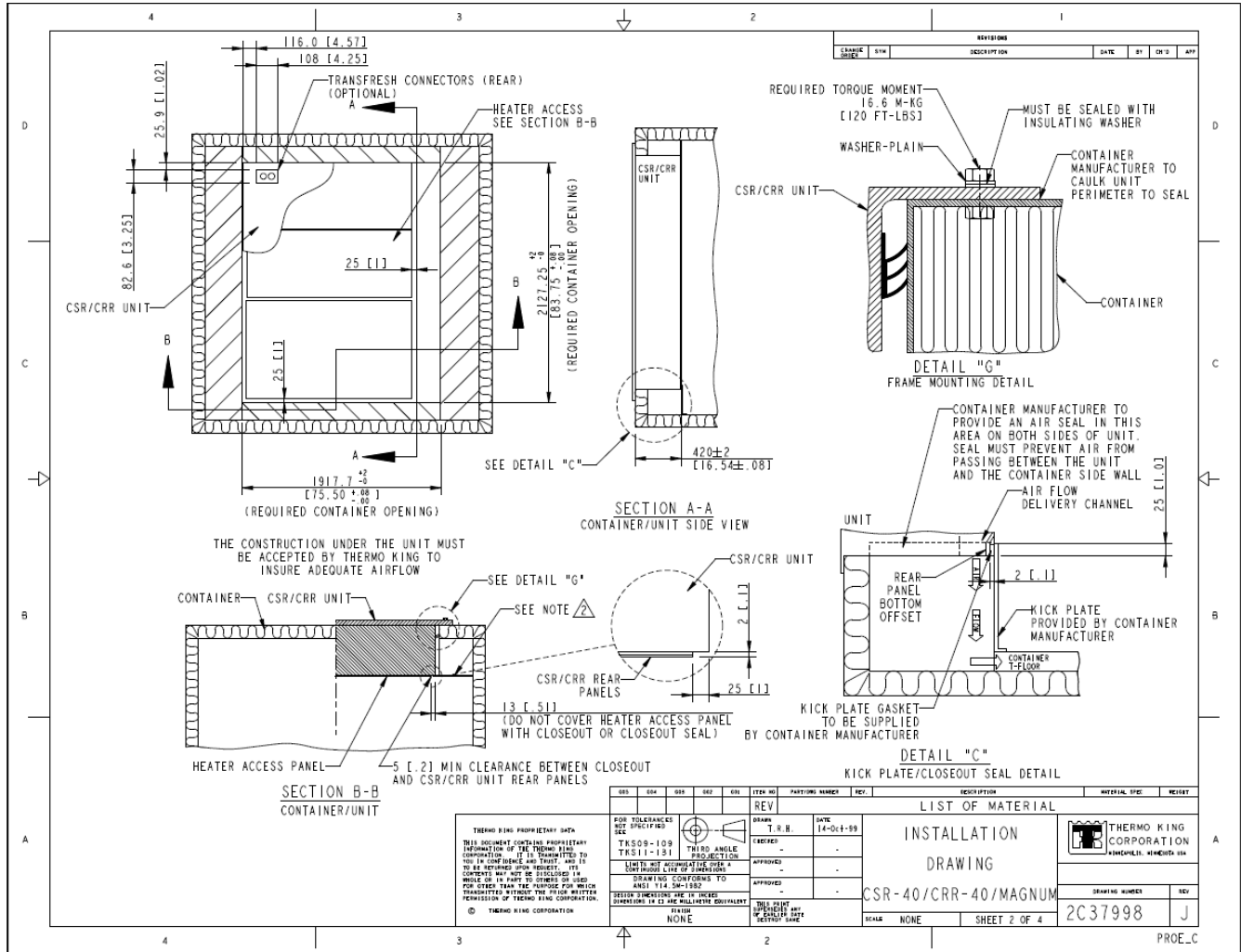

Product specification

Revision Control

| | | |
|-----------|-------------|---------------------------|
| Draft 1.0 | First draft | July 1 st 2020 |
| Rel 1.1 | Released | Jan 11 th 2021 |
| | | |
| | | |
| | | |
| | | |
| | | |
| | | |
| | | |

| |
|--|
| |
|--|